

HazLoc LED Luminaire

NPT Assembly Instructions*:

STEP 1: Inspect port and fitting to ensure that both are free of contaminants and excessive burrs and nicks.

STEP 2: Apply a strip of an anaerobic liquid pipe sealant around the male threads leaving the first two threads uncovered. If no liquid sealant is available, wrap Teflon tape (width of 12.7mm and thickness of 0.1mm) 2.5- 3 turns in a clockwise direction, viewed from the pipe end, leaving the remaining two threads uncovered.

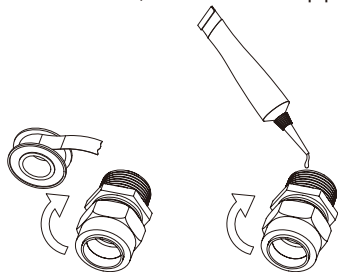

CAUTION: Teflon tape and some pipe sealants are destructive to hydraulic components. Always use extreme caution and follow manufacturer's recommendations for proper application of any sealant in order to prevent contamination.

STEP 3: Screw finger tight into the port

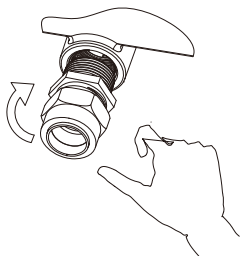

STEP 4: Wrench tighten the fitting to the correct Turns Past Finger Tight position. A properly assembled fittings total thread engagement should be 3.5 to 6 turns.

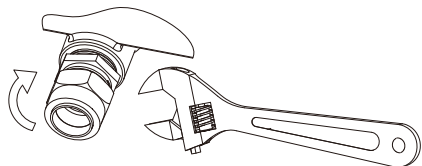

CAUTION: Never back off an installed pipe fitting to achieve proper alignment. Loosening installed pipe fittings will corrupt the seal and contribute to leakage and failure.
(*Applicable standard: ASME B1.20.1-2013)

HazLoc LED Luminaire

General Safety Information

- To reduce the risk of death, personal injury or property damage from fire, electric shock, falling parts, cuts/abrasions and other hazards, please read all warnings and instructions included with and on the fixture box and all fixture labels.
- Before installing, servicing, or performing routine maintenance upon this equipment, please follow these general precautions.
- Commercial installation, service and maintenance of luminaires should be performed by a qualified licensed electrician.
- **DO NOT INSTALL DAMAGED PRODUCT!**
- Make sure that the supply voltage is the same as the luminaire voltage.
- Do not install where the marked operating temperatures exceed the ignition temperatures of the hazardous atmosphere.
- Do not operate in ambient temperatures above those indicated on the luminaire nameplate.
- All gasket seals must be clean and undamaged.



WARNING:

RISK OF ELECTRICAL SHOCK

Luminaire shall have provision for connection to threaded rigid metal conduit or other wiring methods in accordance with Article 502 in the National Electrical Code, NFPA 70.

Turn off electrical power at fuse or circuit breaker box before wiring luminaire to the power supply.

Turn off the power when you perform any maintenance.

Verify that supply voltage is correct by comparing it with the luminaire label information.

Make sure all electrical and grounded connections in accordance with the National Electrical Code and any applicable local code requirements and Hazloc requirements and suitable for wiring system..

All wiring connections should be capped with UL approved wire connectors.

Luminaire must be supplied by a wiring system with an equipment grounding conductor.

CAUTION:

RISK OF INJURY

Tightly close when energized for safety.

Do not open the luminaire after installation.

Wear gloves and safety glasses at all times

when removing luminaire from carton, installing, servicing or performing maintenance.

Avoid direct eye exposure to the light source while it is on.

Properly handle small parts and destroy packing material, as these may be hazardous to children.

Model RDX Series is suitable for use in the following hazardous (classified) areas as defined by the National Electrical Code (NEC) and Canadian Electrical Code (CEC):

Hazardous Locations

Class I, Division 2, Groups A, B, C, D

Class II, Division 1, Groups E, F, G

Class II, Division 2, Groups F, G

Class III, Division 1

Refer to the luminaire nameplate for specific classification information, maximum ambient temperature suitability and corresponding operating temperature (T-Code).

HazLoc LED Luminaire

**CAUTION:
RISK OF FIRE**

Keep combustible and other materials that can burn away from luminaire and lamp/lens.
MIN 90°C SUPPLY CONDUCTORS.

Models:

RDX-2-3-4-5-6-7-8-9

- 2 – Wattage 80 - 80W, 120 - 120W, 150 - 150W, 200 - 200W
- 3 – Voltage 100-277 - 100-277V AC, 120-277 - 120-277V AC, 347-480 - 347-480V AC
- 4 – Color Temperature 3K - 3000K, 4K - 4000K, 5K - 5000K, 57K - 5700K, 65K - 6500K, RD - Red, GN - Green, BU - Blue, AM - Amber
- 5 – Beam Angle T1 - Type I, T5 - Type V
- 6 – Hazloc Rating H2 - C1D2 / C2D1 / C3
- 7 – Lens CG - Clear Glass, DG - Diffuse Glass, DLG - Drop Lens Glass, CP - Clear PC, DP - Diffuse PC, DLP - Drop Lens PC
- 8 – Finish Color GRY – Grey
- 9 – Mounting PDCG - Pendant & Ceiling, YKE - Yoke

Operating characteristic:

Rated voltage	Power	Model	Ambient Temp.
100- 277Vac	80W	RDX-80	-40 C ~+65 C
	120W	RDX-120	
	150W	RDX-150	-40 C ~+60 C
	200W	RDX-200	-40 C ~+55 C
347- 480Vac	80W	RDX-80	-40 C ~+65 C
	120W	RDX-120	
	150W	RDX-150	-40 C ~+60 C
	200W	RDX-200	-40 C ~+55 C

HazLoc LED Luminaire

Servicing

To avoid personal injury, disconnect power to the light and allow the unit to cool down before performing maintenance.
Perform visual, electrical, and mechanical inspections on a regular basis. The environment and frequency of use should determine this. However, it is recommended that checks should be made at least once a year.
The external lens should be cleaned periodically to ensure continued luminaire performance. Clean the lens with a clean, damp, non-abrasive, lint-free cloth. If this is not sufficient, use a mild soap or a liquid cleaner. Do not use an abrasive, strong alkaline or acid cleaner as damage may occur. Inspect the cooling fins of the luminaire to ensure that they are free of any contamination (i.e. excessive dust build-up). Clean with a non-abrasive cloth if needed.
Mechanically check to make sure all parts are properly assembled.
Electrically check to make sure that all connections are clean and tight

Warranty

We warrant that each of our LED lighting luminaire (the “Product(s)”) that are purchased while this Warranty is in effect will be free from defects in materials and workmanship for the period of time specified in the table below (the “Warranty Period”). The Warranty Period runs from the date of original purchase from its authorized distributor/dealer.

We will repair, or at our option, replace the defective product (exterior finish, housing and heat sinks, lens, LED engine, power supply) during the standard warranty period. This warranty applies only to the repair or replacement of the product and only when the product is properly handled, installed and maintained according to our instructions.

This warranty excludes defects resulting from improper installation, acts of God, fire, vandalism or civil disturbances, power surges or improper power supply, and corrosive environment installations.

This warranty does not cover equipment, systems or components from other manufacturers that the Purchaser uses in conjunction with the Product. Any repair, alteration or modification of the Product, including replacement of Product components with components of other manufacturers will void the warranty in its entirety.

Product	Models Covered by Warranty	Warranty Period
Round Max Series Hazloc LED Luminaire	RDX Series	Driver - Five (5) Years LEDs - Ten (10) Years

HazLoc LED Luminaire

5. Wall-90°

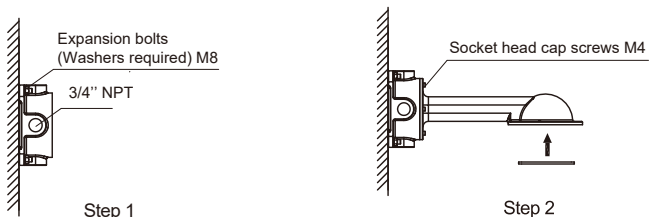

Step 1:
Mark and drill desired location on mounting surface, Secure the junction box (provided) with 4 (M8) expansion bolts (not provided) directly to a structural member; thread onto a NPT 3/4 inch conduit.

Step 2:
Pull field wiring into the wall mount adapter. Secure the adapter with 6 (M4) screws (provided) directly to the junction box. Make sure the gasket of the adapter is properly inserted into the slot.

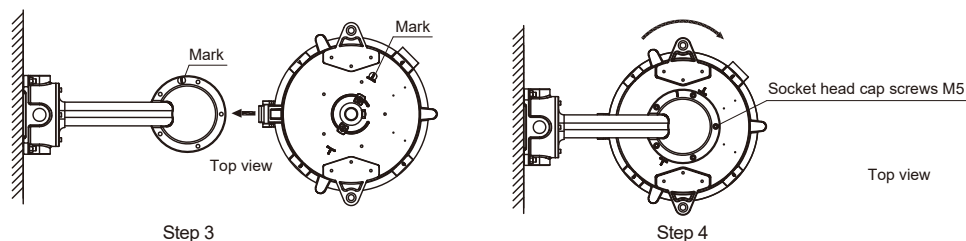

Step 3:
Hang the whole fixture onto the adapter, align as marked.

Step 4:
Rotate the fixture clockwise and secure the adapter with M5 screws (provided) to (5 N-m).

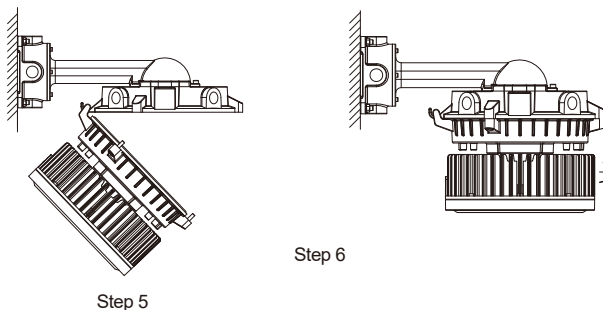

Step 5:
Unscrew the hood and Connect supply wires to luminaire wire leads (or Wago connectors).

Step 6:
Close driver housing, making sure that all wires are safely inside driver. Tighten three captive closing screw (M6) to (6 N-m).
Note: All installation must refer to RSL " NPT Assembly Instructions" to prevent water leakage.

HazLoc LED Luminaire

General Wiring Diagram

CAUTION: Turn off electrical power at fuse or circuit breaker box before wiring luminaire to the power supply.

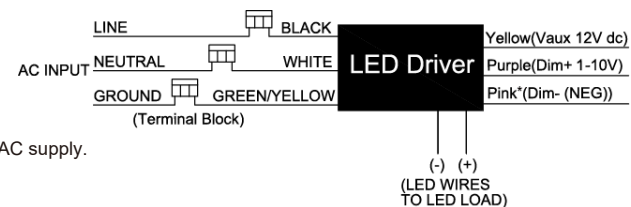

All units must be individually connected to the AC supply.

- Black = Line
- White = Neutral
- Green = Ground

Dimming control wire: Yellow =Vaux 12V dc
Purple = Dim+ 1~10V input
Pink*= Dim- (NEG)

* You might receive the lead in grey from a previous version.

Installation & Operation

Electrical Connection

1. Loosen the eight pcs of M6 hexagon bolts of Tank Cover at torque value 6 N-m.
2. The thread of entry hole of Tank is 3/4" NPT. Connect the Tank to suitable conduit.
3. Inset the wire from outside through the conduit and the entry hole of Tank, and then connect to terminal block.
4. Wire the branch circuit as follows:
Black-wire connects to Line
White-wire connects to Neutral
Green-wire connects to Ground
5. Re-attach the Driver Cover and tighten it by eight pcs of M6 hexagon bolts of Driver Cover at torque value 6 N-m.
6. Check the tightness of conduit and Driver Cover.

Product Size:

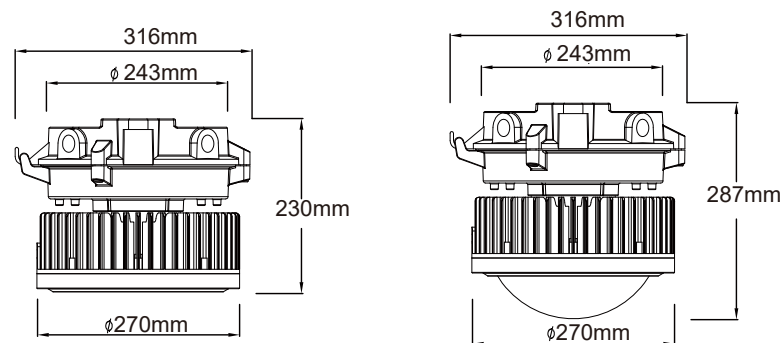

HazLoc LED Luminaire

Installation:

1. Ceiling



Step 1

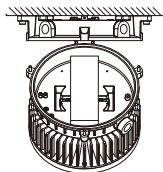

Step 2

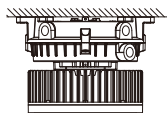

Step 3

Step 1:
Mark and drill desired location on mounting surface. Secure the hood with 4 (M10) expansion bolts (not provided) directly to a structural member; thread onto a NPT 3/4 inch conduit.

Step 2:
Hang the fixture onto the hinge hook of the hood. Connect supply wires to luminaire wire leads (or Wago connectors provided)

Step 3:
Close driver housing, making sure that all wires are safely inside driver. Tighten three captive closing screw (M6) to (6 N-m).

Note: All installation must refer to RSL " NPT Assembly Instructions" to prevent water leakage.

2. Bracket

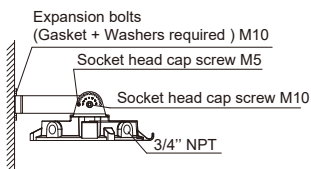

Step 1

Figure 1a

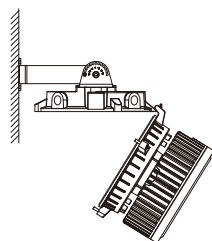

Step 2

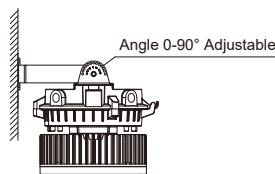

Step 3

Step 1:
Secure the bracket and hood with 4 (M10) expansion bolts (not provided) directly to a structural member; make sure the hinge is located as marked, See Figure 1a.

Adjust the angle (6x15°) of the bracket and fix the position with M5 screws (provided).

Step 2:
Hang the fixture onto the hinge hook of the hood. Connect supply wires to luminaire wire leads (or Wago connectors).

Step 3:
Close driver housing, making sure that all wires are safely inside driver. Tighten three captive closing screw (M6) to (6 N-m).

Note: All installation must refer to RSL " NPT Assembly Instructions" to prevent water leakage.

HazLoc LED Luminaire

3. Pendant

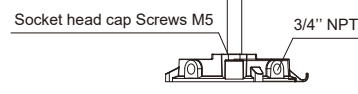

Step 1

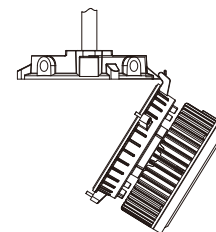

Step 2

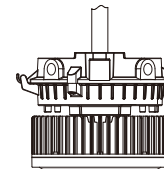

Step 3

Step 1:
Thread the pendant hood onto the NPT 3/4 inch conduit. Tighten the M5 set-screw.

Step 2:
Hang the fixture onto the hinge hook of the hood. Connect supply wires to luminaire wire leads (or Wago connectors).

Step 3:
Close driver housing, making sure that all wires are safely inside driver. Tighten three captive closing screw (M6) to (6 N-m).

Note: All installation must refer to RSL " NPT Assembly Instructions" to prevent water leakage.

4. Stanchion 90° / Stanchion 25°

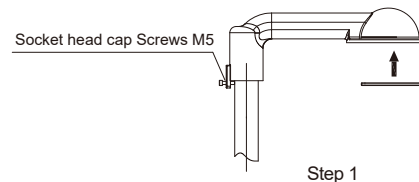

Step 1

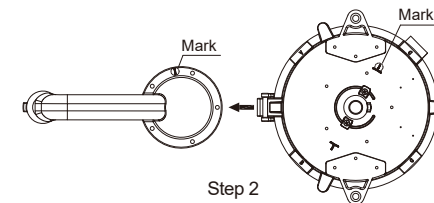

Step 2

Step 1:
Securely thread the adapter onto the appropriate NPT size conduit. Determine the appropriate orientation and tighten the M5 set-screw. Make sure the gasket of the adapter is properly inserted into the slot .

Step 2:
Hang the whole fixture onto the adapter, align as marked.

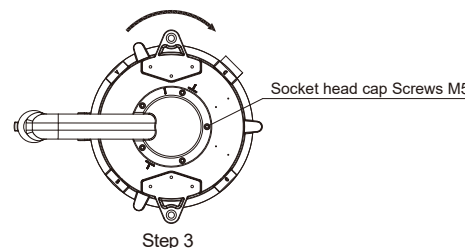

Step 3

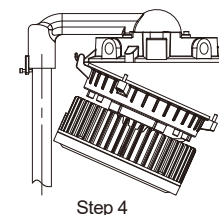

Step 4

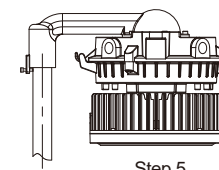

Step 5

Step 3:
Rotate the fixture clockwise and secure the adapter with M5 screws (provided) to (5 N-m).

Step 4:
Unscrew the hood and Connect supply wires to luminaire wire leads (or Wago connectors).

Step 5:
Close driver housing, making sure that all wires are safely inside driver. Tighten three captive closing screw (M6) to (6 N-m).

Note: All installation must refer to RSL " NPT Assembly Instructions" to prevent water leakage.