

# LINEAR SERIES

LED LIGHTING FOR HARSH AND HAZARDOUS AREAS  
AREA & LOWBAY



**Reliable. Durable. Efficient.**  
**4,000 to 12,000 lumen models**

**RED SKY**  
SERIOUSLY SAFE LIGHTS™

## ABOUT RED SKY LIGHTING

# PIONEERING INDUSTRIAL ILLUMINATION FOR HARSH & HAZARDOUS CONDITIONS

- A leading manufacturer of premium LED lights for demanding work conditions
- Headquartered in California, products assembled in the USA
- Servicing global clients across 4 continents in metal processing, oil & gas, marine, manufacturing
- Renowned for quality, dependability, client care and uncompromising safety standards

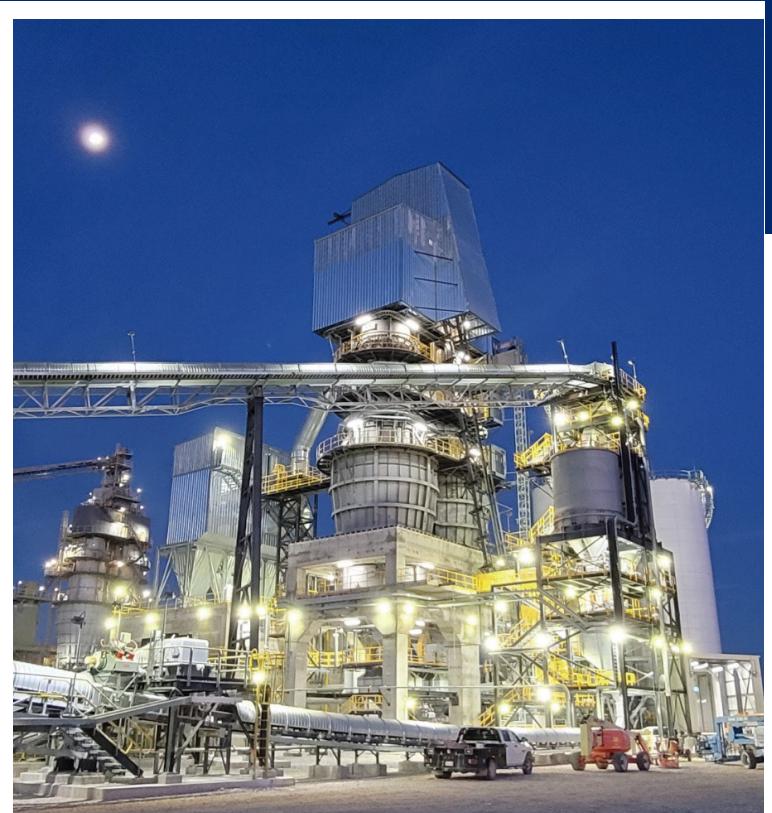

## WHY CHOOSE RED SKY

### ❧ SERIOUSLY SAFE LIGHTS

- Rigorously tested in our professional labs
- Surpassing industry certifications and safety protocols
- Crafted with highest grade components for maximum durability

### ❧ TOP-NOTCH SERVICES

- Team of experts for seamless support
- Energy audit services, lighting simulation services
- Hassle-free return policy and management

### ❧ FAST DELIVERY

- Majority of orders delivered within 14 days
- Same day shipping for products in stock
- Real-time order tracking for full transparency

### ❧ SUSTAINABLE SOLUTIONS

- High luminous efficacy LEDs for energy savings
- Conscious product design
- Recyclable materials for products and packaging



# LINEAR SERIES

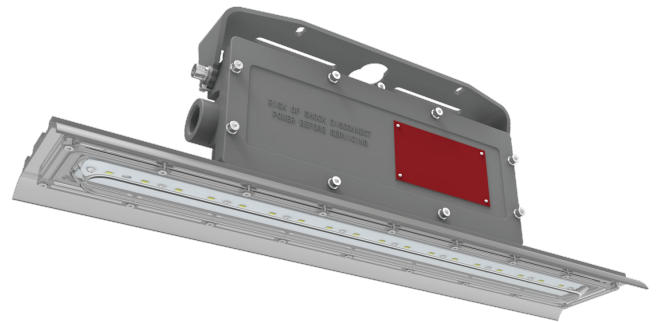

With its rugged copper-free aluminum construction, the Linear Series is rated for hazardous environments up to Class I Division 2, protecting against combustible dust, gases, and vapors. Featuring a maintenance-free design, the Linear Series ensures over 147,000 hours of reliable light output at temperatures up to 149°F (65°C), while its robust design and quality enable operation under temperatures as low as -40°F (-40°C).

With durable materials and first-in-class craftsmanship, it withstands extreme temperatures, vibration, water, and dust — ensuring long-lasting performance even in the most punishing industrial settings. Its dimmable 1-10V driver and high luminous efficacy of up to 150 lumens per watt help maximize energy savings without compromising illumination levels.

For easy installation, the Linear Series includes a built-in wiring compartment with three 3/4" NPT conduit entries and WAGO connectors. It also offers multiple mounting options for suspended, wall, or surface installations. An optional bracket allows for simple retrofits of existing fixtures.

Purpose-built for industrial use, the Linear Series is a purpose-built solution delivering durable, efficient linear lighting for demanding hazardous work environments. Red Sky Lighting backs the Linear Series with an industry-leading 10-year warranty and factory replacement. Choose the Linear Series for exceptional performance, advanced safety, and unmatched durability in hazardous industrial environments.



**LINEAR SERIES**  
ILLINOIS, USA

**FEATURES**

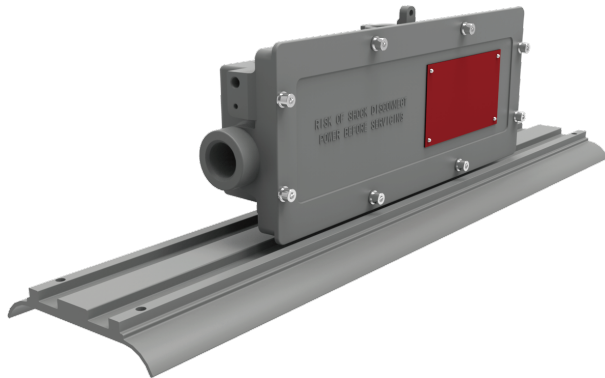

**Rugged Construction**

Built to withstand extreme temperatures, vibration, water and dust. Copper-free aluminum body and frame for corrosion-resistant

**Easy and Through Wiring**

Built-in wiring compartment with three NPT 3/4" entries and WAGO 221 lever connectors for easy wiring

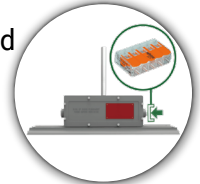

**Multiple Mounting Options**

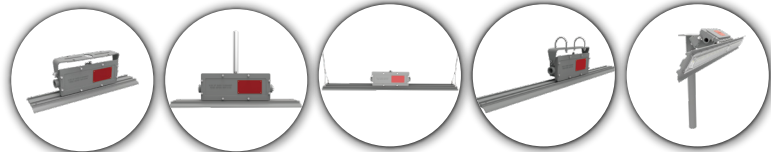

**Long Fixture Life**

L70 >147,000 Hours@149°F  
Maintenance-free and safe operation

**RATINGS**

Class I Division 2, Groups A, B, C, D	Simultaneous Presence
Class II Division 1 Group E, F, G	UL 1598 Wet Locations
Class II Division 2, Groups F, G	UL 1598A Marine Outside Type (Salt Water)
Class III	IP66
Class I, Zone 2, Group IIC	IK08
Zone 21, Group IIIC	Salt Spray 720 hrs (ISO 9227)

**CERTIFICATIONS**

UL844  
UL1598  
UL1598A  
CSA C22.2 NO. 250.0  
CSA C22.2 No. 137  
DLC (Pending)  
FCC Part 15, Subpart B

# TECHNICAL PARAMETERS

Specification	LNR2-30	LNR2-40	LNR2-60	LNR2-80
<b>Electrical Parameters</b>				
Power	30W	40W	60W	80W
Rated Input Current(100V AC)	0.277A	0.370A	0.555A	0.740A
Rated Input Current(277V AC)	0.120A	0.160A	0.240A	0.320A
Rated Input Current(347V AC)	/	0.128A	0.192A	0.256A
Rated Input Current(480V AC)	/	0.092A	0.138A	0.185A
Voltage/Frequency	100-277V AC, 347-480V AC 50/60Hz			
Power Factor	≥0.90			
THD	<20%			
L70	147,000 hrs@149°F			
Dimming*	0-10V, Range 10-100%			
Surge Protection(100-277Vac)	10KV	10KV	6KV	
Surge Protection(347-480Vac)	/	L\N-FG 4KV, L-N 2KV		6KV
Supply Wire	12-18AWG, Rated 90°C			
Warranty	LEDs: 10 years, Driver: 7 years			
<b>Optical Parameters</b>				
Lumen Output**	4,426Lm	5,795Lm	9,185Lm	12,026Lm
Lumen Efficacy**	150Lm/W			
Correlated Color Temperature (CCT)	3000K/4000K/5000K			
Color Rendering Index (CRI)	Ra>70			
<b>Mechanical Parameters</b>				
Housing Material	Copper-free (< 0.4%) aluminum			
Hardware	Stainless steel 316			
Lens Material	Polycarbonate			
Mounting Options	Pendant, Yoke, Chain, Pole, Stanchion			
Product Weight	11.0lbs/5.0kg		14.68lbs/6.66kg	
Package Weight	13.1lbs/6.0kg		16.78lbs/7.66kg	
Cable Entry	(3) 3/4" NPT			
Product Dimensions(L×W×H)	23.6×5.0×6.6in(600×127×168mm)		47.2×5.0×6.6in(1200×127×168mm)	
Package Dimensions(L×W×H)	26.4×5.9×7.9in(670×150×200mm)		50.4×6.3×8.3in(1280×160×210mm)	
<b>Environmental Parameters</b>				
Ambient Operating Temperature	C1D2@-40°F ~ 149°F (-40°C ~ 65°C), C2D1@-40°F ~ 122°F (-40°C ~ 50°C)			
T-Code Rating	T4A			
EPA wind rating (FT2)	1.463(Yoke), 1.448(Stanchion)		1.972(Yoke), 1.957(Stanchion)	

\* LNR2-40-347-480V Dimming Unavailable

\*\* Value calculated based on 5000K and Clear glass ,varies to different spec.

# ORDERING INFORMATION

EXAMPLE: LNR2-40-100-277-5K-H2-CP-GRY-PND

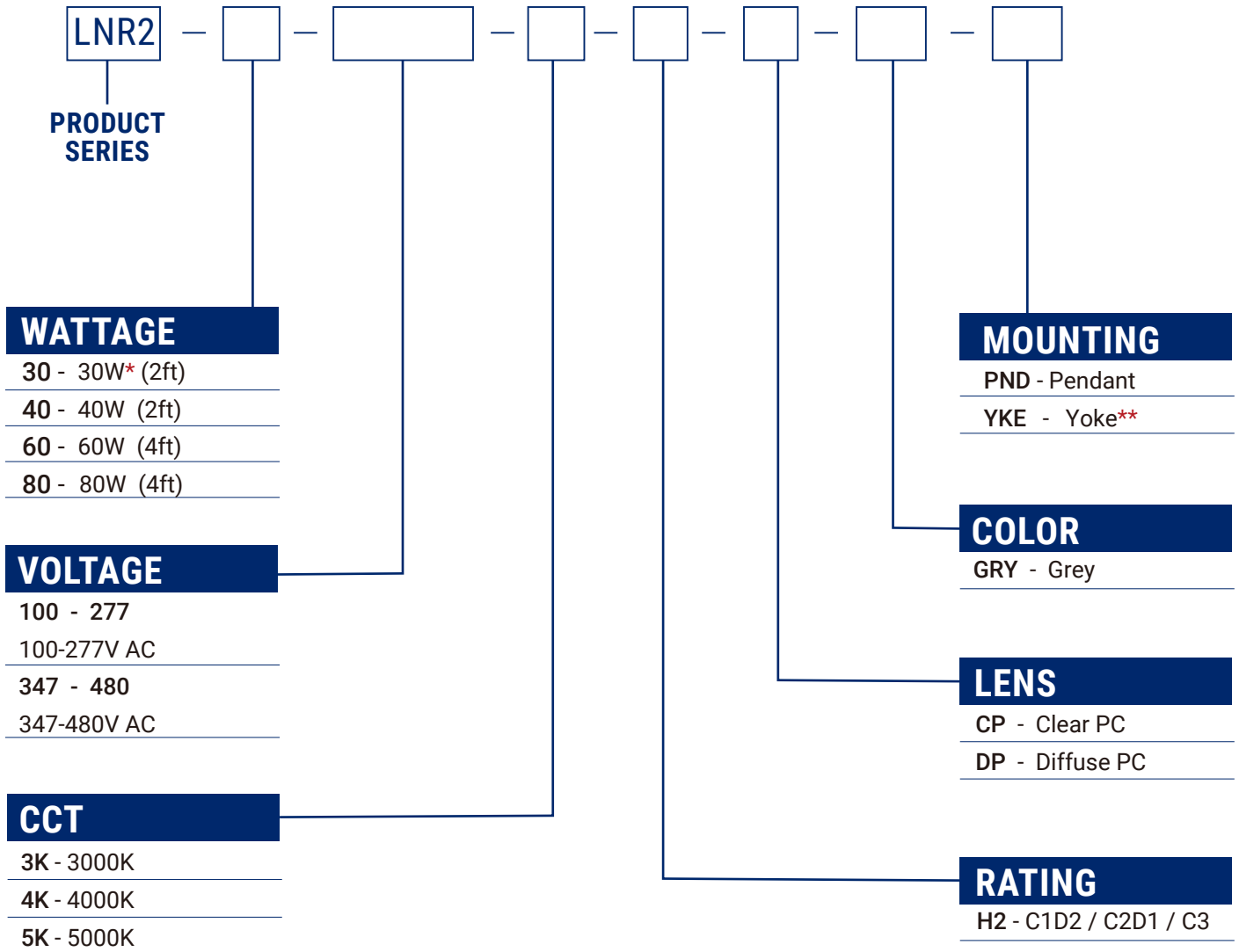

\* unavailable in 347-480V AC

\*\* LNR-YOKE Pre-installed

# MOUNTING ACCESSORIES

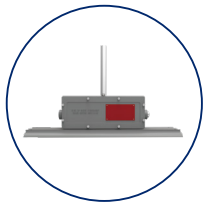

Pendant

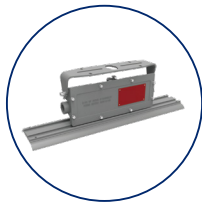

Yoke

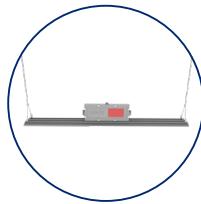

Chain

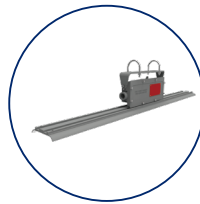

Pole

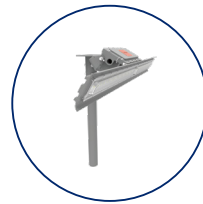

Stanchion



LNR-YOKE

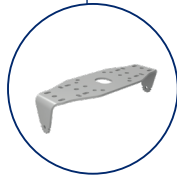

LNR-YOKE P

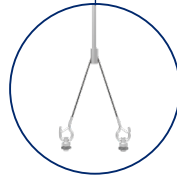

CHAIN01



CLAMP01/02



STAN01

Mounting Method	PN	Description	MPN Code
Yoke	LNR-YOKE	Yoke Mount, LNR SERIES, SS304, Power Coated Grey RAL7037	309050042
	LNR-YOKE P*	Retrofit Yoke Mount, LNR SERIES, SS304, Power Coated Grey RAL7037	309050332
Chain	CHAIN01	Chain Hang Kit, LNR&LNT SERIES, SS304	309050071
Pipe clamp	CLAMP01	Pipe Clamp Kit for Round pole $\Phi$ 1 7/8(48mm), SS304	309050047
	CLAMP02	Pipe Clamp Kit for Round pole $\Phi$ 2 3/8(60mm), SS304	309050046
Stanchion	STAN01**	Slip-Fit Stanchion Mount Kit for $\Phi$ 2" (2 3/8" OD) Poles Non-threaded, SUS304, powder coated, RAL7037	309050300

## \* Retrofit Bracket Compatibility Chart

For customers trying to retrofit an existing fixture, use the table below as a guide to select the best bracket to suit your need

Manufacturer	Part Number	Retrofit Yoke
Crouse Hinds	DP057MTK	✓
Dialight	LTXW4	✓
	LTXW4LP	✓
AZZ™ Rig-A-Lite™	53050	✓
Appleton	RMLSB	✓

\*\* Requires A Yoke Mount

# OTHER ACCESSORIES



SFCB03

PN	Description	MPN Code
SFCB03	Safety Cable Kit, LNR SERIES, SS304	309050049
GLCO-03	3ft Cord (SOOW 14AWG*3, 105°C, 600V) with cable gland, for C1D2 and non-hazardous only	204020003
GLCO-10	10ft Cord (SOOW 14AWG*3, 105°C, 600V) with cable gland, for C1D2 and non-hazardous only	204020004

## **REPLACEMENT PARTS (ORDERED SEPARATELY)**

Part Number	Description	MPN Code
LNR2-30-100-277-Driver	Replacement Driver Kit for LNR2-30-100-277 Fixtures	303010042
LNR2-40-100-277-Driver	Replacement Driver Kit for LNR2-40-100-277 Fixtures	303010043
LNR2-60-100-277-Driver	Replacement Driver Kit for LNR2-60-100-277 Fixtures	303010044
LNR2-80-100-277-Driver	Replacement Driver Kit for LNR2-80-100-277 Fixtures	303010045
LNR2-40-347-480-Driver	Replacement Driver Kit for LNR2-40-347-480 Fixtures	303010046
LNR2-60-347-480-Driver	Replacement Driver Kit for LNR2-60-347-480 Fixtures	303010047
LNR2-80-347-480-Driver	Replacement Driver Kit for LNR2-80-347-480 Fixtures	303010048
LNR2-CP	Replacement Clear PC Lens for LNR2 Fixtures, order 1 for 30/40W, 2 for 60/80W Fixtures	303030012
LNR2-DP	Replacement Diffuse PC Lens for LNR2 Fixtures, order 1 for 30/40W, 2 for 60/80W Fixtures	303030013

## **LUMEN TABLE**

PN	Wattage (W)	CCT	Beam	Lens	Lumen Output (Lm)	Efficiency (Lm/W)
<b>Voltage 100-277V AC</b>						
LNR2-30-100-277-5K-110-H2-CP-GRY-YKE	30	5000K	110°	Clear PC	4,426	152
LNR2-30-100-277-5K-110-H2-DP-GRY-YKE	30	5000K	110°	Diffuse PC	3,949	136
LNR2-40-100-277-5K-110-H2-CP-GRY-YKE	40	5000K	110°	Clear PC	5,795	151
LNR2-40-100-277-5K-110-H2-DP-GRY-YKE	40	5000K	110°	Diffuse PC	5,171	135
LNR2-60-100-277-5K-110-H2-CP-GRY-YKE	60	5000K	110°	Clear PC	9,185	158
LNR2-60-100-277-5K-110-H2-DP-GRY-YKE	60	5000K	110°	Diffuse PC	8,256	143
LNR2-80-100-277-5K-110-H2-CP-GRY-YKE	80	5000K	110°	Clear PC	12,026	155
LNR2-80-100-277-5K-110-H2-DP-GRY-YKE	80	5000K	110°	Diffuse PC	10,785	139
<b>Voltage 347-480V AC</b>						
LNR2-40-347-480-5K-110-H2-CP-GRY-YKE	40	5000K	110°	Clear PC	5,902	153
LNR2-40-347-480-5K-110-H2-DP-GRY-YKE	40	5000K	110°	Diffuse PC	5,372	139
LNR2-60-347-480-5K-110-H2-CP-GRY-YKE	60	5000K	110°	Clear PC	9,597	157
LNR2-60-347-480-5K-110-H2-DP-GRY-YKE	60	5000K	110°	Diffuse PC	8,621	141
LNR2-80-347-480-5K-110-H2-CP-GRY-YKE	80	5000K	110°	Clear PC	12,182	157
LNR2-80-347-480-5K-110-H2-DP-GRY-YKE	80	5000K	110°	Diffuse PC	10,993	142

For additional information, please contact your sales representative.



# A DIRECT RETROFIT FROM HID TO LED

The LNR series LED is easy to retrofit in the same configuration as your existing HID luminaires. For example, a 80-watt Linear (LNR2-80) delivers virtually the same illumination as its equivalent 250 watt Metal Halide luminaire while providing 80% reduction in energy costs and up to 147,000 hours of continuous operation.







MODELS	Lumen Output (Lm)	MH Equivalent (W)	HPS Equivalent (W)
LNR2-20	4,426	100	100
LNR2-40	5,795	150	150
LNR2-60	9,185	200	250
LNR2-80	12,026	250	310

# THE RIGHT BEAM PATTERN FOR YOUR APPLICATION

RSL optic package is engineered to deliver maximum footcandles efficiently where you need them, without wasted light or overspill.

RSL offers complimentary lighting design services for our products using industry-leading AGI32 software, tailored for projects of all sizes in harsh and hazardous locations. We assist you in determining the number of fixtures needed, the types of lights to use, their optimal placement, and how to maximize energy savings—all within budget.

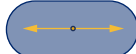
Simply fill out the form (<https://dev.redskylighting.com/lighting-design>) with a few key details, request a layout, and we'll bring your ideas to life within 2-5 business days.

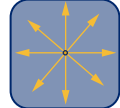
Beam	NEMA/IESNA Type	Beam Description	Beam Projection Distance
30°	NEMA 3	Medium Narrow	
60°	NEMA 4	Medium	
90°	NEMA 5	Medium Wide	
120°	NEMA 6	Wide	
T1	Type I	Asymmetric distributions, well suited for narrow areas, such as Conveyor belts, Aisleways, Catwalks, Loading docks and Tunnels.	
T2	Type II	Asymmetric distributions, well suited for narrow areas, such as roadways, paths and driveways.	
T3	Type III	Asymmetric distributions, well suited for site / area perimeters, wide roadways, and open areas.	
T5	NEMA 7 Type V (Square)	Very Wide: symmetrical pattern with excellent uniformity for large, open areas.	

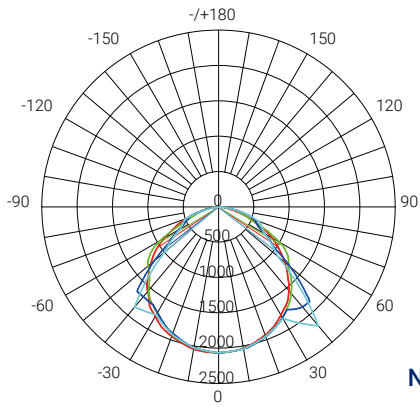

110°  
NEMA 6 - Wide

## DIMENSIONS

unit: in(mm)

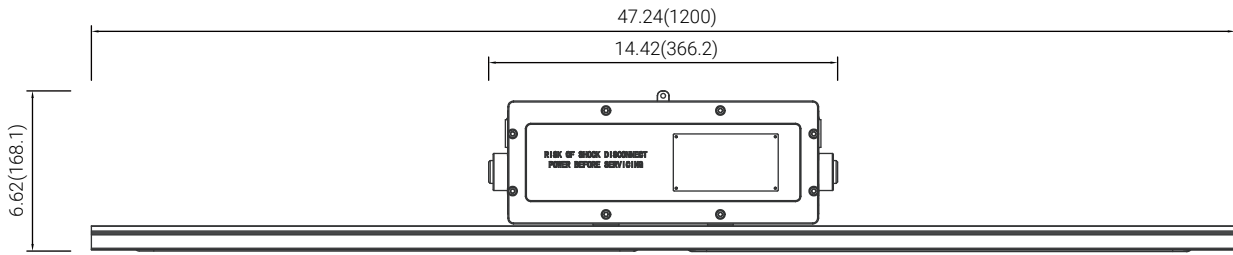
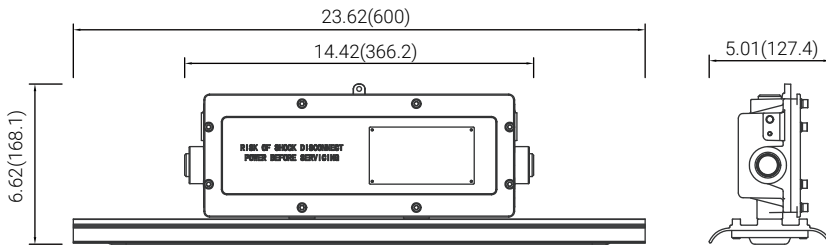

Pendant

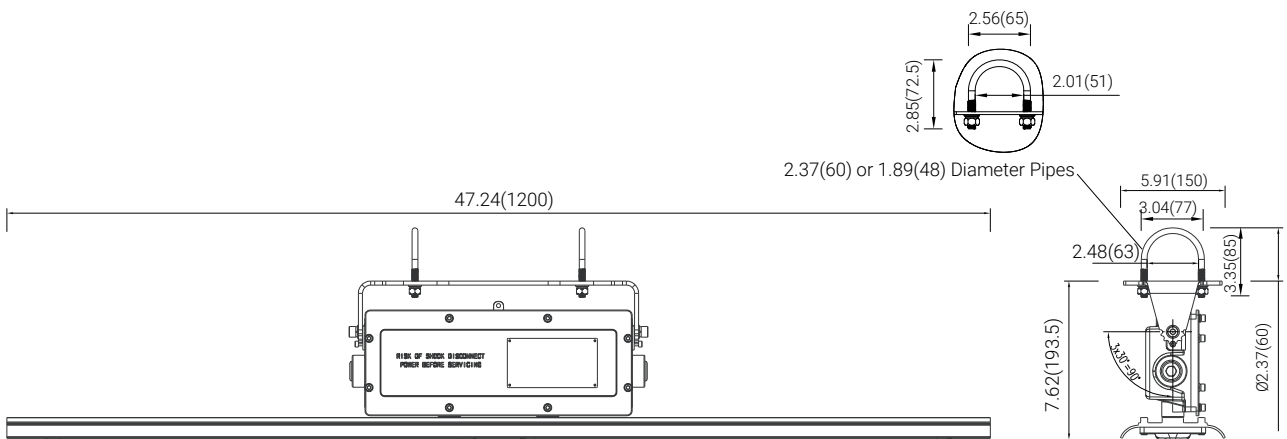

Pole

unit: in(mm)

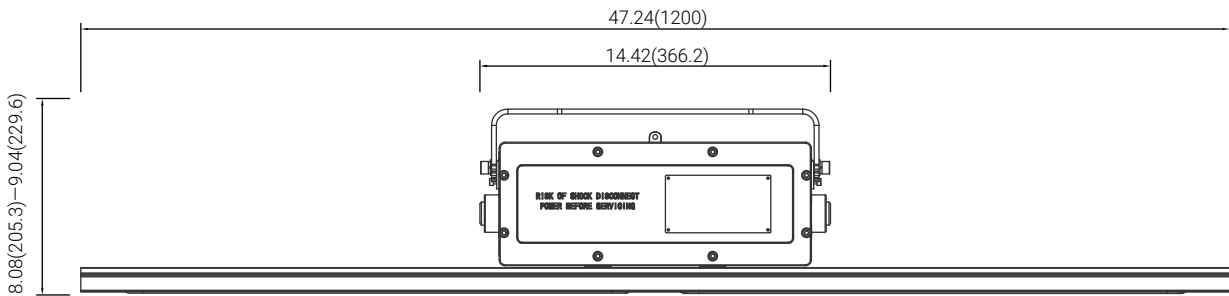
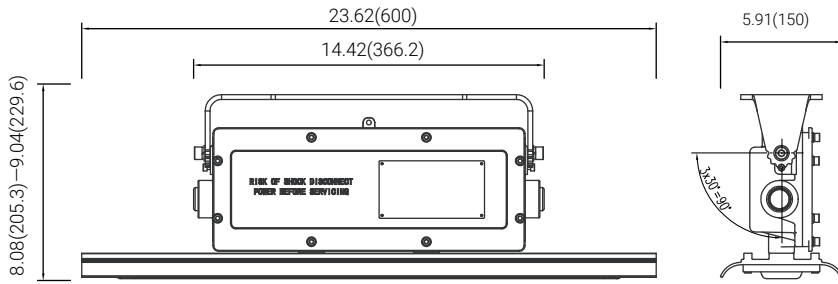

## Yoke

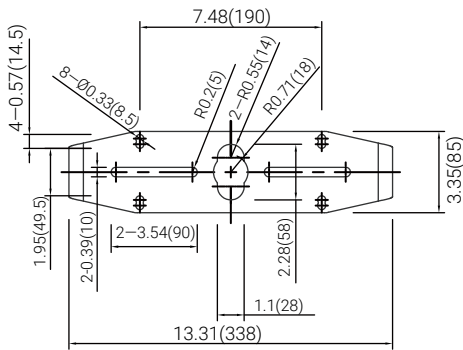

LNR-YOKE

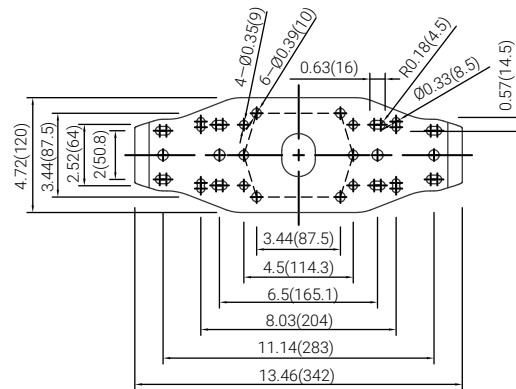

LNR-YOKE P

unit: in(mm)

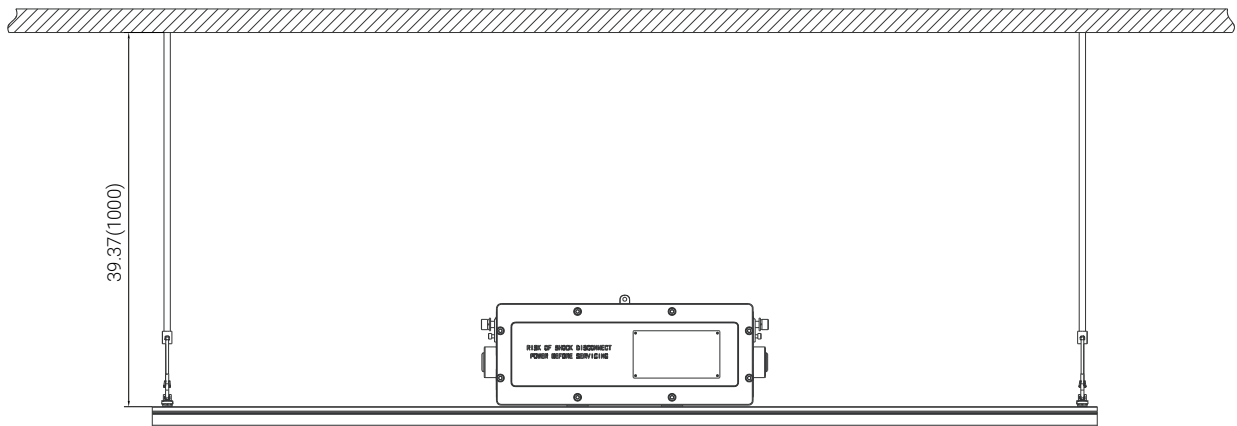

Chain

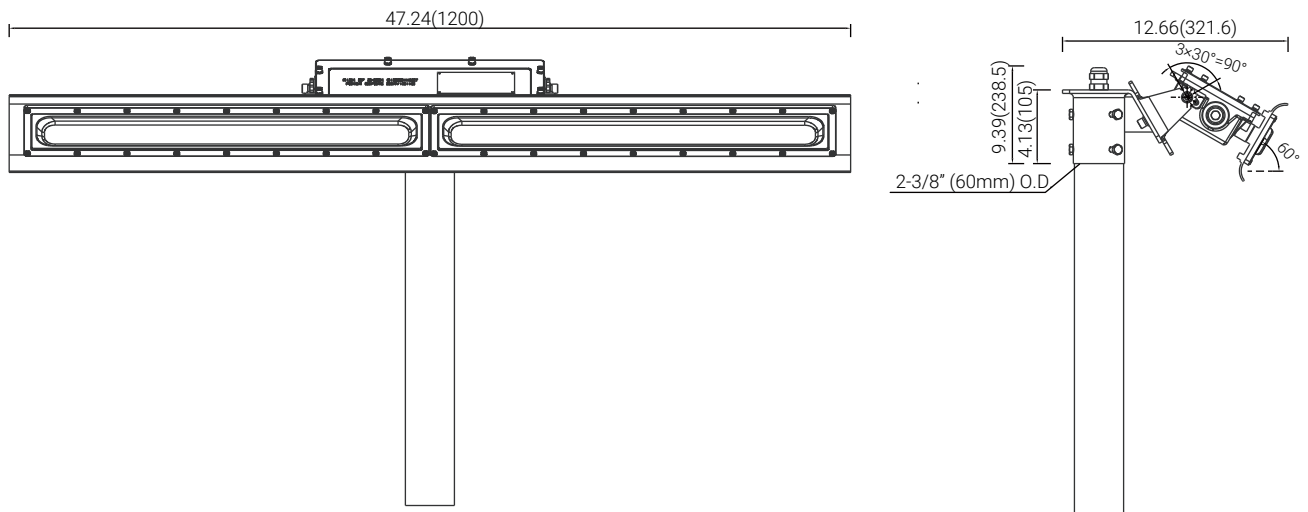

Stanchion

# HAZARDOUS LOCATION LIGHTING BASICS

## Atmosphere Groups

## Temperature Classification

Substance	Hazard Class	Division Groups	Zone Groups	Max. Surface Temperatures	NEC®500 CEC®	NEC®500/IEC-Group II
Acetylene	Class I Flammable Gases	Group A	IIC	450°C(842°F)	T1	T1
Hydrogen		Group B	IIC	300°C(572°F)	T2	
Ethylene		Group C	IIB	280°C(536°F)	T2A	T2
Propane		Group D	IIA	260°C(500°F)	T2B	
Methane		Group D	IIA <sup>2</sup>	230°C(446°F)	T2C	
Combustible Metal Dusts	Group E <sup>1</sup>	IIIC <sup>3</sup>	215°C(419°F)	T2D		
Combustible Carbonaceous Dust	Class II Combustible Dusts	Group F	IIIB <sup>3</sup>	200°C(392°F)	T3	T3
Combustible Dusts not in Group E or F (Flour, Grain, Wood, Plastics, Chemicals)		Group G	IIIB <sup>3</sup>	180°C(256°F)	T3A	
Combustible Fibers and Flyings		Not Applicable	IIIA <sup>3</sup>	165°C(329°F)	T3B	
				160°C(320°F)	T3C	
				135°C(275°F)	T4	T4
				120°C(248°F)	T4A	
				100°C(212°F)	T5	T5
				85°C(185°F)	T6	T6

Note 1: Group E is applicable to Class II, Division 1 only.  
 Note 2: Methane is a Group IIA Gas for non-mining applications.  
 Note 3: Group IIIA, IIIB and IIIC have not been adopted by the Canadian Electrical Code.

## Classification of Divisions and Zones

Hazard Level	Division Scheme	Zone Scheme	Definitions
Continuous Hazard	Division 1	Zone 0 / Zone 20	A place in which an explosive atmosphere is continually present
Intermittent Hazard		Zone 1 / Zone 21	A place in which an explosive atmosphere is likely to occur in normal operation
Hazard Under Abnormal Conditions	Division 2	Zone 2 / Zone 22	A place in which an explosive atmosphere is not likely to occur in normal operation, but may occur for short periods

## IP Codes

1st No.	Solid Objects
0	No protection
1	Objects greater than 50mm
2	Objects greater than 12.5mm
3	Objects greater than 2.5mm
4	Objects greater than 1mm
5	Dust protected
6	Dust proof
2nd No.	Liquids
0	No protection
1	Vertically dripping
2	Dripping up to 15°
3	Limited spraying
4	Splashing from all directions
5	Hosing jets from all directions
6	Strong hosing jets from all directions
7	Temporary immersion
8	Continuous immersion
9	Steam-jet cleaning

## IK Ratings

IK Code	Level of Protection Achieved
IK00	Not protected
IK01	Protected against 0.14 joules impact
IK02	Protected against 0.2 joules impact
IK03	Protected against 0.35 joules impact
IK04	Protected against 0.5 joules impact
IK05	Protected against 0.7 joules impact
IK06	Protected against 1 joules impact
IK07	Protected against 2 joules impact
IK08	Protected against 5 joules impact
IK09	Protected against 10 joules impact
IK10	Protected against 20 joules impact

RED SKY LIGHTING LLC  
9370 Pittsburgh Ave  
Rancho Cucamonga, CA 91730, USA

1(262) 456-5002  
[contact@redskylighting.com](mailto:contact@redskylighting.com)  
[www.redskylighting.com](http://www.redskylighting.com)

**RED SKY**  
SERIOUSLY SAFE LIGHTS™